

NCP1510A

Up to 500 mA, High Efficiency Synchronous Step-Down DC-DC Converter in Chip Scale Package

The NCP1510A step-down PWM DC-DC converter is optimized for portable applications powered from 1-cell Li-ion or 3-cell Alkaline/NiCd/NiMH batteries. This DC-DC converter utilizes a current-mode control architecture for easy compensation and better line regulation. It also uses synchronous rectification to increase efficiency and reduce external part count. The NCP1510A optimizes efficiency in light load conditions when switched from a normal PWM mode to a "pulsed switching" mode. The device also has a built-in oscillator for the PWM circuitry, or it can be synchronized to an external 500 kHz to 1000 kHz clock signal. Finally, it includes an integrated soft-start, cycle-by-cycle current limiting, and thermal shutdown protection. The NCP1510A is available in a space saving, 9 pin chip scale package.

Features

- High Efficiency:
 - 92.5% for 1.8 V Output at 3.6 V Input and 125 mA Load Current
 - 91.5% for 1.8 V Output at 3.6 V Input and 300 mA Load Current
- Digital Programmable Output Voltages: 1.05, 1.35, 1.57 or 1.8 V
- Output Current up to 500 mA at $V_{in} = 3.6$ V
- Low Quiescent Current of 14 μ A in Pulsed Switching Mode
- Low 0.1 μ A Shutdown Current
- -30°C to 85°C Operation Temperature
- Ceramic Input/Output Capacitor
- 9 Pin Chip Scale Package
- Pb-Free Package is Available

Applications

- Cellular Phones, Smart Phones and PDAs
- Digital Still Cameras
- MP3 Players and Portable Audio Systems
- Wireless and DSL Modems
- Portable Equipment

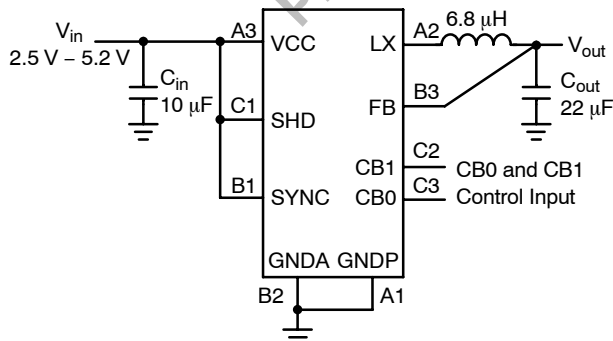

Figure 1. Typical Application Circuit



ON Semiconductor®

<http://onsemi.com>



9 PIN
MICRO BUMP
FC SUFFIX
CASE 499AC

DBB = Specific Device Code
A = Assembly Location
Y = Year
WW = Work Week

MARKING DIAGRAM

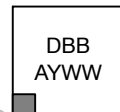

PIN CONNECTIONS

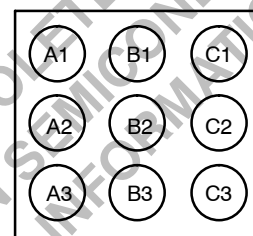

(Bottom View)

Pin: A1 - GNDP
A2 - LX
A3 - VCC
B1 - SYNC
B2 - GNDA
B3 - FB
C1 - SHD
C2 - CB1
C3 - CB0

ORDERING INFORMATION

Device	Package	Shipping†
NCP1510AFCT1	Micro Bump	3000 Tape & Reel
NCP1510AFCT1G	Micro Bump (Pb-Free)	3000 Tape & Reel

† For information on tape and reel specifications, including part orientation and tape sizes, please refer to our Tape and Reel Packaging Specifications Brochure, BRD8011/D.

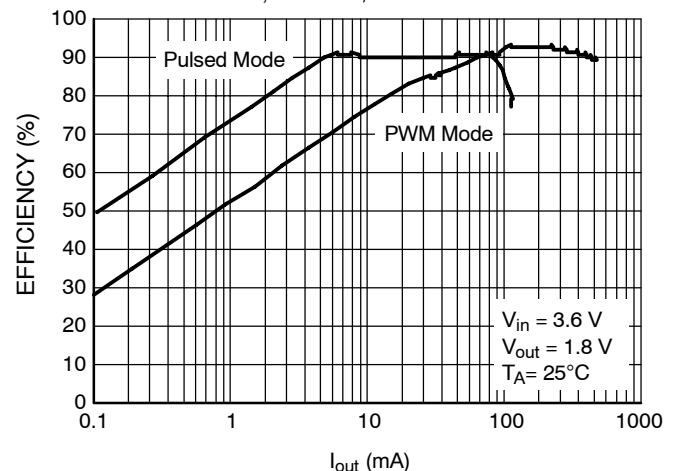

Figure 2. PWM versus Pulse Efficiency Comparison

NCP1510A

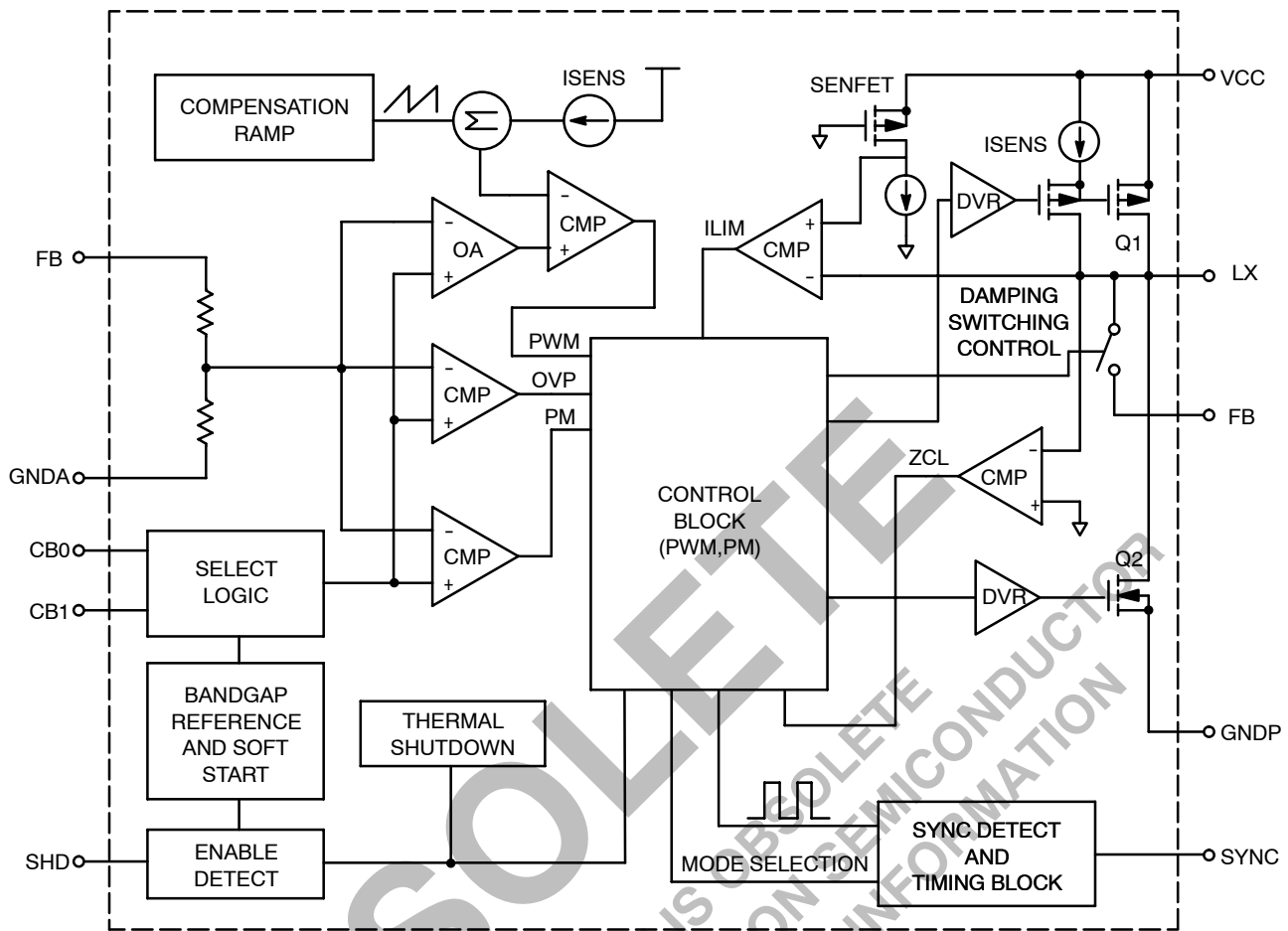

Figure 3. Simplified Block Diagram

PIN FUNCTION DESCRIPTION

Pin No.	Symbol	Type	Description
A1	GNDP	Power Ground	Ground Connection for the NFET Power Stage.
A2	LX	Analog Output	Connection from Power Pass Elements to the Inductor.
A3	V _{CC}	Analog Input	Power Supply Input for Power and Analog V _{CC} .
B1	SYNC	Analog Input	Synchronization input for the PWM converter. If a clock signal is present, the converter uses the rising edge for the turn on. If this pin is low, the converter is in the Pulsed mode. If this pin is high, the converter uses the internal oscillator for the PWM mode. This pin contains an internal pull down resistor.
B2	GND A	Analog Ground	Ground connection for the Analog Section of the IC. This is the GND for the FB, Ref, Sync, CB, and SHD pins.
B3	FB	Analog Input	Feedback Voltage from the Output of the Power Supply.
C1	SHD	Analog Input	Enable for Switching Regulator. This Pin is Active High to enable the NCP1510A. The SHD Pin has an internal pull down resistor to force the converter off if this pin is not connected to the external circuit.
C2	CB1	Analog Input	Selects V _{out} . This pin contains an internal pull up resistor.
C3	CB0	Analog Input	Selects V _{out} . This pin contains an internal pull down resistor.

NCP1510A

MAXIMUM RATINGS

Rating	Symbol	Value	Unit
Maximum Voltage All Pins	V_{max}	5.5	V
Maximum Operating Voltage All Pins	V_{max}	5.2	V
Thermal Resistance, Junction-to-Air (Note 1)	$R_{\theta JA}$	159	°C/W
Operating Ambient Temperature Range	T_A	-30 to 85	°C
ESD Withstand Voltage	Human Body Model (Note 2) Machine Model (Note 2)	V_{ESD} > 2500 > 150	V
Moisture Sensitivity	MSL	Level 1	
Storage Temperature Range	T_{stg}	-55 to 150	°C
Junction Operating Temperature	T_J	-30 to 125	°C

Stresses exceeding Maximum Ratings may damage the device. Maximum Ratings are stress ratings only. Functional operation above the Recommended Operating Conditions is not implied. Extended exposure to stresses above the Recommended Operating Conditions may affect device reliability.

1. For the 9-Pin Micro Bump package, the $R_{\theta JA}$ is highly dependent of the PCB heatsink area. $R_{\theta JA} = 159^{\circ}\text{C/W}$ with 50 mm² PCB heatsink area.
2. This device series contains ESD protection and exceeds the following tests:
 - Human Body Model, 100 pF discharge through a 1.5 k Ω following specification JESD22/A114.
 - Machine Model, 200 pF discharged through all pins following specification JESD22/A115.
 - Latchup as per JESD78 Class II: > 100 mA.

OBSOLETE
THIS DEVICE IS OBSOLETE
PLEASE CONTACT YOUR ON SEMICONDUCTOR
REPRESENTATIVE FOR INFORMATION

NCP1510A

ELECTRICAL CHARACTERISTICS ($V_{in} = 3.6\text{ V}$, $V_o = 1.57\text{ V}$, $T_A = 25^\circ\text{C}$, $F_{syn} = 600\text{ kHz}$ 50% Duty Cycle square wave for PWM mode; $T_A = -30\text{ to }85^\circ\text{C}$ for Min/Max values, unless otherwise noted.)

Characteristic	Symbol	Min	Typ	Max	Unit
----------------	--------	-----	-----	-----	------

V_{CC} Pin

Quiescent Current of Sync Mode, $I_{out} = 0\text{ mA}$	Iq PWM	–	175	–	μA
Quiescent Current of PWM Mode, $I_{out} = 0\text{ mA}$	Iq PWM	–	185	–	μA
Quiescent Current of Pulsed Mode, $I_{out} = 0\text{ mA}$	Iq Pulsed	–	14	–	μA
Quiescent Current, SHD Low	Iq Off	–	0.1	0.5	μA
Input Voltage Range (Note 3)	V_{in}	2.5	–	5.2	V

Sync Pin

Input Voltage	Vsync	–0.3	–	$V_{cc} + 0.3$	V
Frequency Operational Range	Fsync	500	600	1000	kHz
Minimum Synchronization Pulse Width	Dcsync Min	–	30	–	%
Maximum Synchronization Pulse Width	Dcsync Max	–	70	–	%
SYNC “H” Voltage Threshold	Vsynch	–	920	1200	mV
SYNC “L” Voltage Threshold	Vsyncl	400	830	–	mV
SYNC “H” Input Current, $V_{sync} = 3.6\text{ V}$	Isynch	–	2.2	–	μA
SYNC “L” Input Current, $V_{sync} = 0\text{ V}$	Isyncl	–0.5	–	–	μA

Output Level Selection Pins

Input Voltage	Vcb	–0.3	–	$V_{cc} + 0.3$	V
CB0, CB1 “H” Voltage Threshold	Vcb h	–	920	1200	mV
CB0, CB1 “L” Voltage Threshold	Vcb l	400	830	–	mV
CB0 “H” Input Current, $CB = 3.6\text{ V}$	Icb0 h	–	2.2	–	μA
CB0 “L” Input Current, $CB = 0\text{ V}$	Icb0 l	–0.5	–	–	μA
CB1 “H” Input Current, $CB = 3.6\text{ V}$	Icb1 h	–	0.3	1.0	μA
CB1 “L” Input Current, $CB = 0\text{ V}$	Icb1 l	–	–2.2	–	μA

Shutdown Pin

Input Voltage	Vshd	–0.3	–	$V_{cc} + 0.3$	V
SHD “H” Voltage Threshold	Vshd h	–	920	1200	mV
SHD “L” Voltage Threshold	Vshd l	400	830	–	mV
SHD “H” Input Current, $SHD = 3.6\text{ V}$	Ishd h	–	2.2	–	μA
SHD “L” Input Current, $SHD = 0\text{ V}$	Ishd l	–0.5	–	–	μA

Feedback Pin

Input Voltage	Vfb	–0.3	–	$V_{cc} + 0.3$	V
Input Current, $V_{fb} = 1.57\text{ V}$	Ifb	–	5.0	7.5	μA

3. Recommended maximum input voltage is 5 V when the device frequency is synchronized with an external clock signal.

NCP1510A

ELECTRICAL CHARACTERISTICS ($V_{in} = 3.6\text{ V}$, $V_o = 1.57\text{ V}$, $T_A = 25^\circ\text{C}$, $F_{syn} = 600\text{ kHz}$ 50% Duty Cycle square wave for PWM mode; $T_A = -30\text{ to }85^\circ\text{C}$ for Min/Max values, unless otherwise noted.

Characteristic	Symbol	Min	Typ	Max	Unit
----------------	--------	-----	-----	-----	------

Sync PWM Mode Characteristics

Switching P-FET Current Limit	I_{lim}	–	800	–	mA
Minimum On Time	$T_{on\ min}$	–	75	–	nsec
Rdson Switching P-FET and N_FET	R_{dson}	–	0.23	–	Ω
Switching P-FET and N-FET Leakage Current	I_{leak}	–	0	1.0	μA
Output Overvoltage Threshold	V_o	–	3.0	–	%
Feedback Voltage Accuracy, V_{out} Set = 1.05 V $C_{B0} = L$, $C_{B1} = L$	V_{out}	1.018	1.050	1.082	V
Feedback Voltage Accuracy, V_{out} Set = 1.35 V, $C_{B0} = L$, $C_{B1} = H$	V_{out}	1.309	1.350	1.391	V
Feedback Voltage Accuracy, V_{out} Set = 1.57 V, $C_{B0} = H$, $C_{B1} = H$	V_{out}	1.523	1.570	1.617	V
Feedback Voltage Accuracy, V_{out} Set = 1.8 V, $C_{B0} = H$, $C_{B1} = L$	V_{out}	1.746	1.800	1.854	V
Load Transient Response 10 to 100 mA Load Step	V_{out}	–	35	–	mV
Line Transient Response, $I_{out} = 100\text{ mA}$ 3.0 to 3.6 V_{in} Line Step	V_{out}	–	± 10	–	mVpp

PWM Mode with Internal Oscillator Characteristics

Switching P-FET Current Limit	I_{lim}	–	800	–	mA
Minimum On Time	$T_{on\ min}$	–	75	–	nsec
Internal Oscillator Frequency	F_{osc}	700	900	1200	kHz
Rdson Switching P-FET and N_FET	R_{dson}	–	0.23	–	Ω
Switching P-FET and N-FET Leakage Current	I_{leak}	–	0	1.0	μA
Output Overvoltage Threshold	V_o	–	5.0	–	%
Feedback Voltage Accuracy, V_{out} Set = 1.05 V, $C_{B0} = L$, $C_{B1} = L$	V_{out}	1.018	1.050	1.082	V
Feedback Voltage Accuracy, V_{out} Set = 1.35 V, $C_{B0} = L$, $C_{B1} = H$	V_{out}	1.309	1.350	1.391	V
Feedback Voltage Accuracy, V_{out} Set = 1.57 V, $C_{B0} = H$, $C_{B1} = H$	V_{out}	1.523	1.570	1.617	V
Feedback Voltage Accuracy, V_{out} Set = 1.8 V, $C_{B0} = H$, $C_{B1} = L$	V_{out}	1.746	1.800	1.854	V
Load Transient Response 10 to 100 mA Load Step	V_{out}	–	35	–	mV
Line Transient Response, $I_{out} = 100\text{ mA}$ 3.0 to 3.6 V_{in} Line Step	V_{out}	–	± 10	–	mVpp

Pulsed Mode Characteristics

On Time	T_{on}	–	660	–	nsec
Output Ripple Voltage, $I_{out} = 100\ \mu\text{A}$	V_{out}	–	22	–	mV
Feedback Voltage Accuracy, V_{out} Set = 1.05 V, $C_{B0} = L$, $C_{B1} = L$	V_{out}	0.998	1.050	1.102	V
Feedback Voltage Accuracy, V_{out} Set = 1.35 V, $C_{B0} = L$, $C_{B1} = H$	V_{out}	1.289	1.350	1.411	V
Feedback Voltage Accuracy, V_{out} Set = 1.57 V, $C_{B0} = H$, $C_{B1} = H$	V_{out}	1.503	1.570	1.637	V
Feedback Voltage Accuracy, V_{out} Set = 1.8 V, $C_{B0} = H$, $C_{B1} = L$	V_{out}	1.726	1.800	1.874	V

NCP1510A

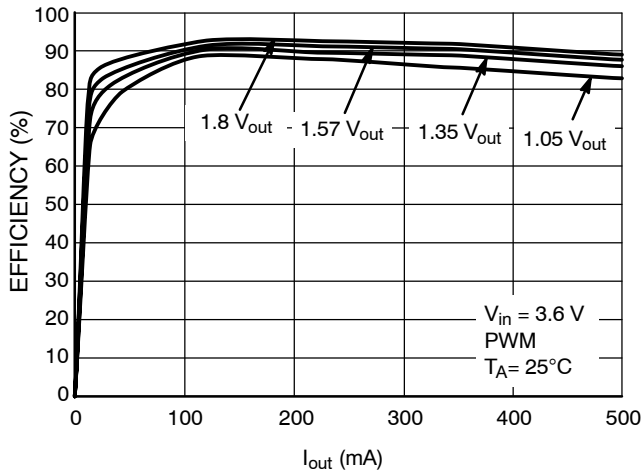

Figure 4. Efficiency vs. Output Current in PWM Mode

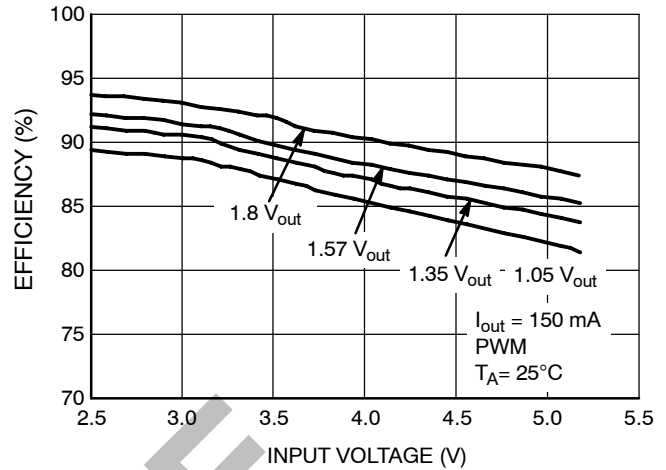

Figure 5. Efficiency vs. Input Voltage in PWM Mode

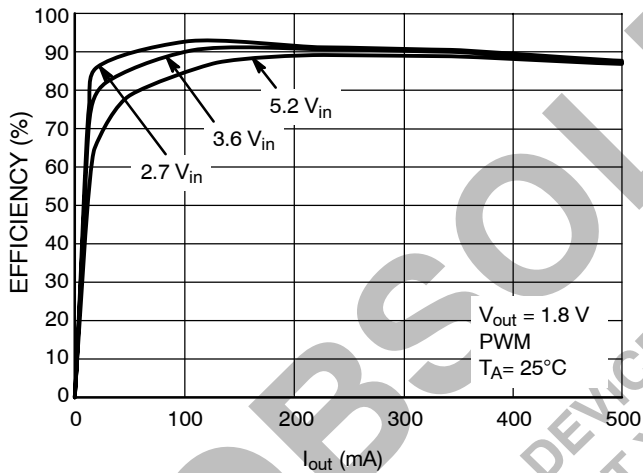

Figure 6. Efficiency vs. Output Current at Different Input Voltage

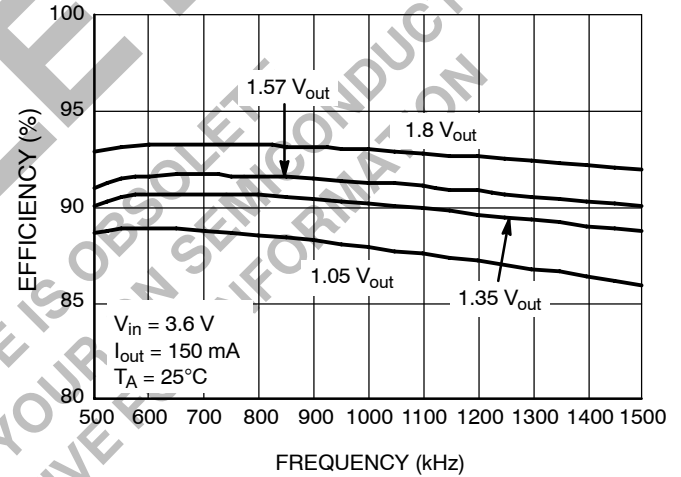

Figure 7. Efficiency vs. Frequency at Iout = 150 mA

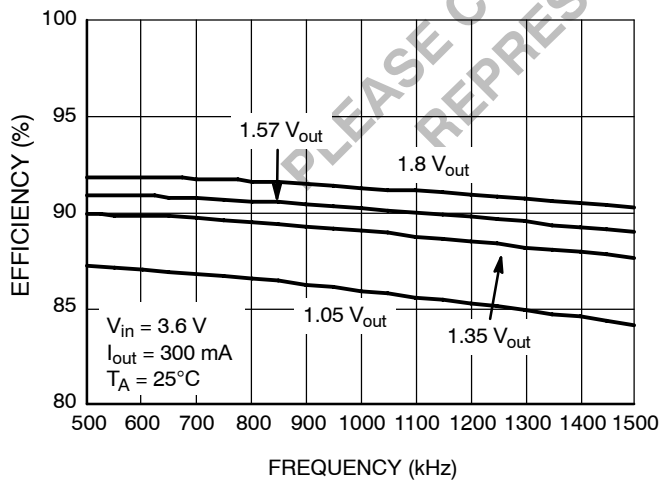

Figure 8. Efficiency vs. Frequency at Iout = 300 mA

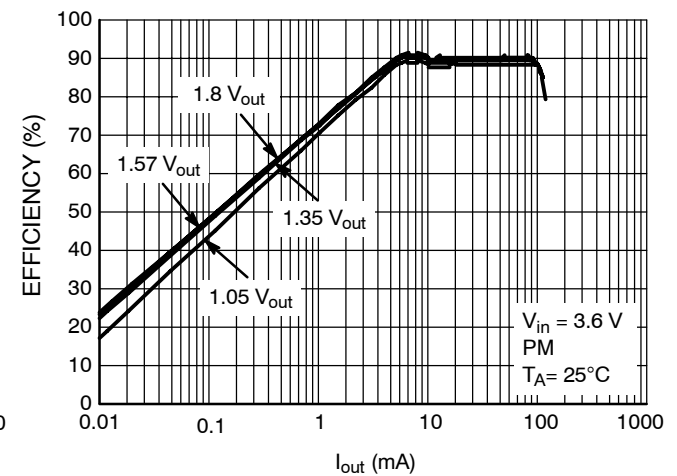

Figure 9. Efficiency vs. Output Current in Pulsed Mode

NCP1510A

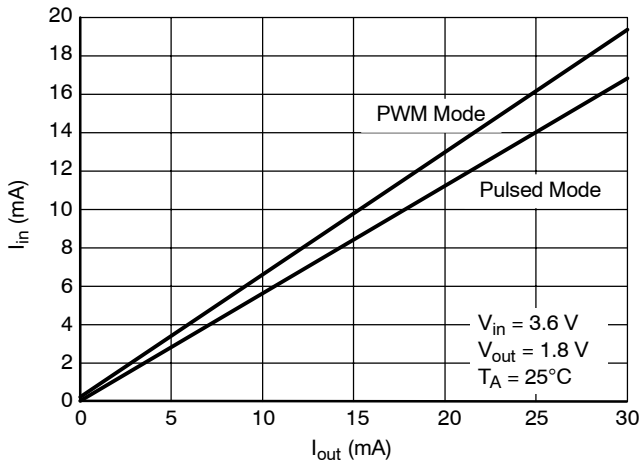

Figure 10. Input Current Comparison

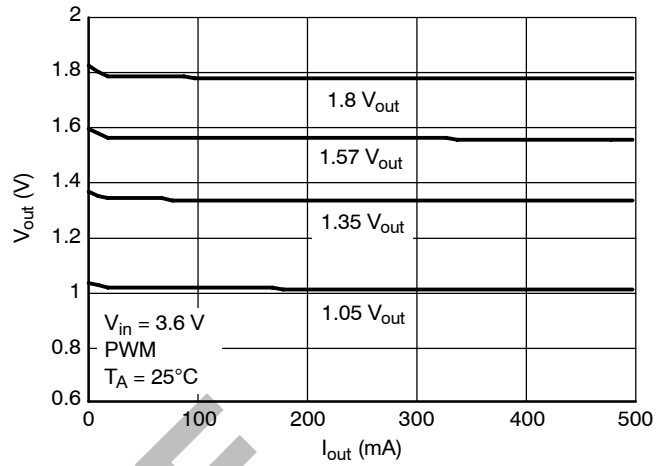

Figure 11. Output Voltage vs. Output Current

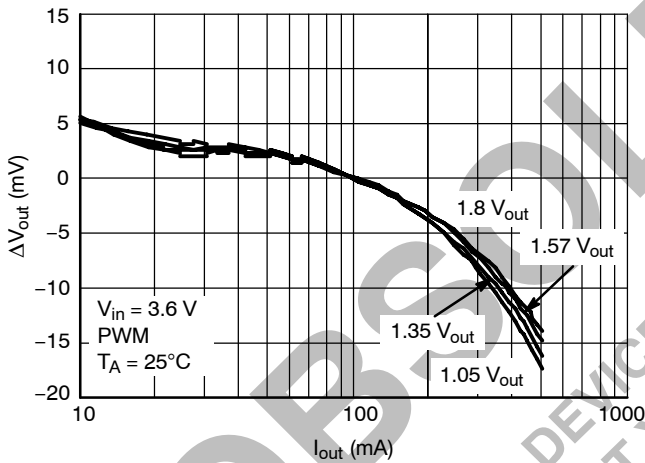

Figure 12. Load Regulation in PWM Mode

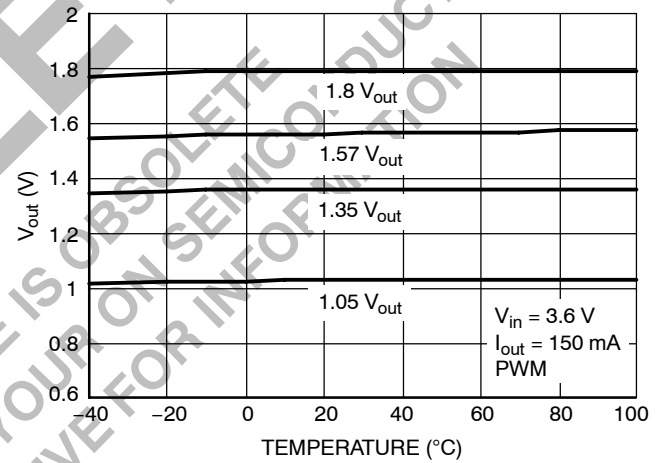

Figure 13. Output Voltage vs. Temperature

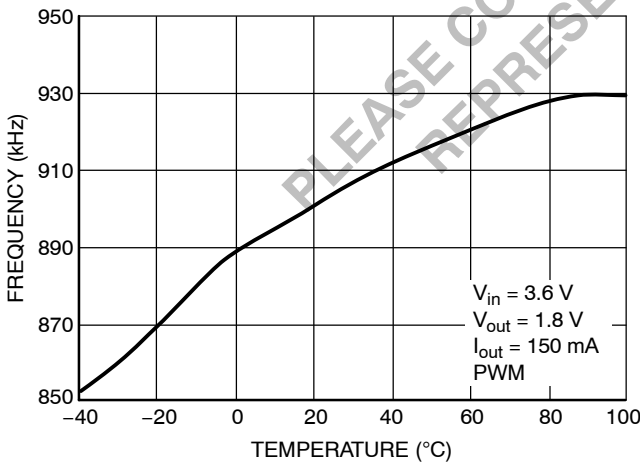

Figure 14. Oscillator Frequency vs. Temperature

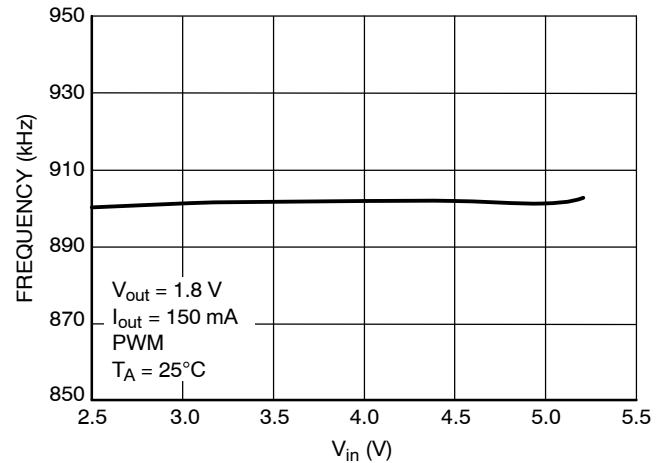

Figure 15. Oscillator Frequency vs. Input Voltage

NCP1510A

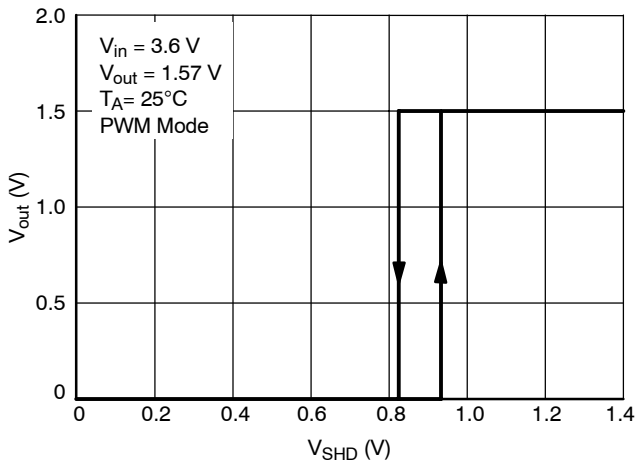

Figure 16. Output Voltage vs. Shutdown Pin Voltage

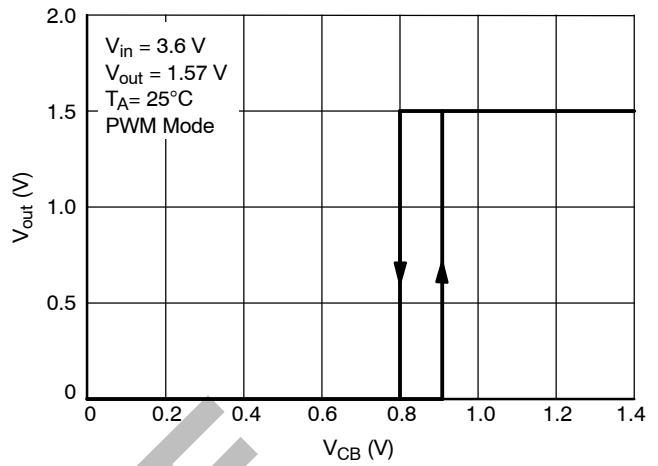

Figure 17. Transition Level of CB Pins

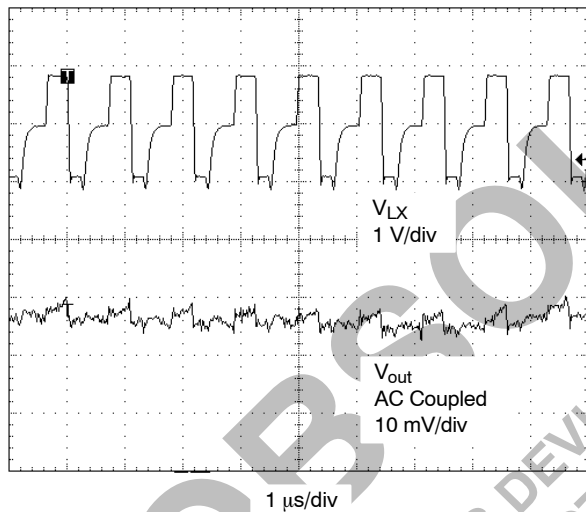

Figure 18. Light Load PWM Switching Waveform
($V_{in} = 3.6\text{ V}$, $V_{out} = 1.8\text{ V}$, $I_{out} = 30\text{ mA}$)

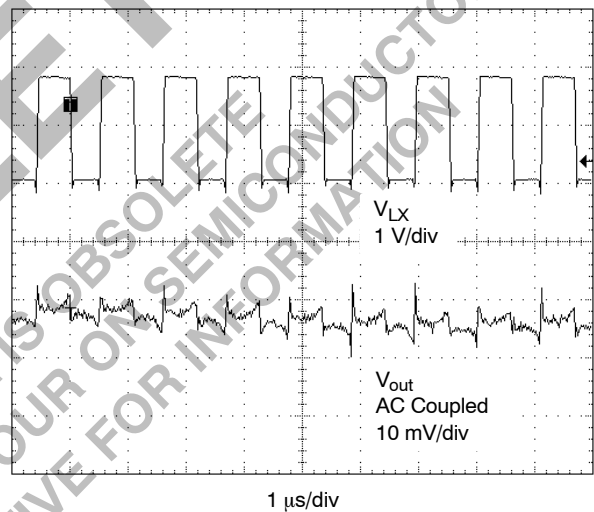

Figure 19. Heavy Load PWM Switching Waveform
($V_{in} = 3.6\text{ V}$, $V_{out} = 1.8\text{ V}$, $I_{out} = 300\text{ mA}$)

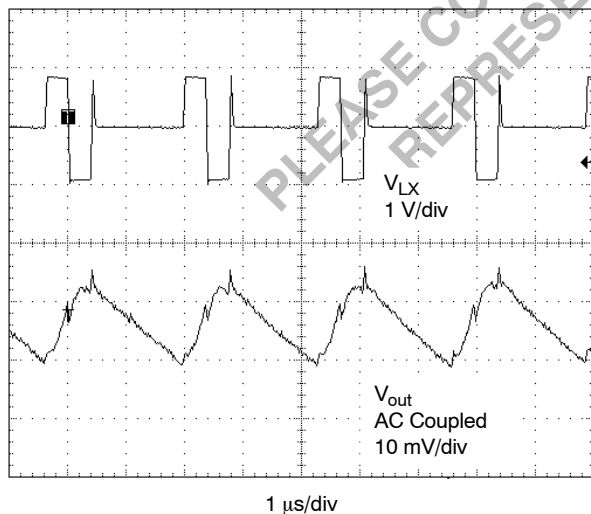

Figure 20. Pulsed Mode Switching Waveform
($V_{in} = 3.6\text{ V}$, $V_{out} = 1.8\text{ V}$, $I_{out} = 30\text{ mA}$)

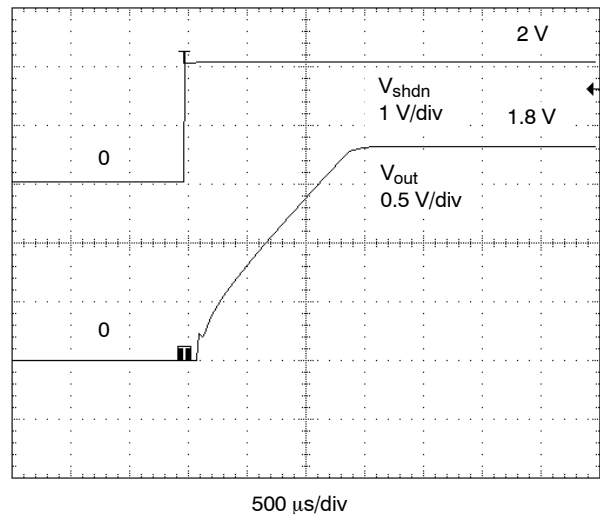

Figure 21. Soft-Start
($V_{in} = 3.6\text{ V}$, $V_{out} = 1.8\text{ V}$, $I_{out} = 150\text{ mA}$)

NCP1510A

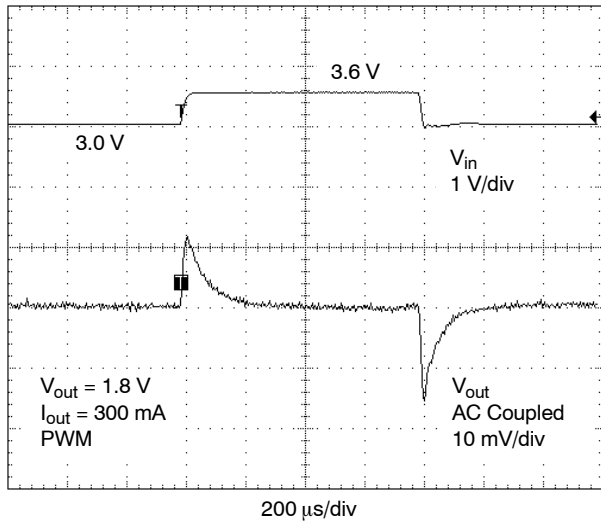

Figure 22. Line Transient Response for PWM

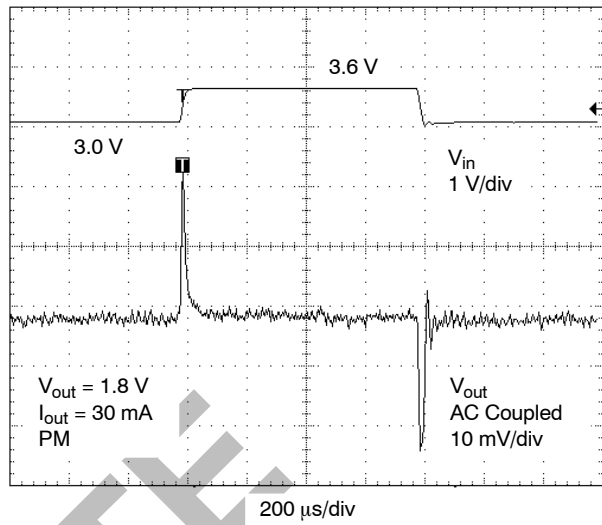

Figure 23. Line Transient Response for PM

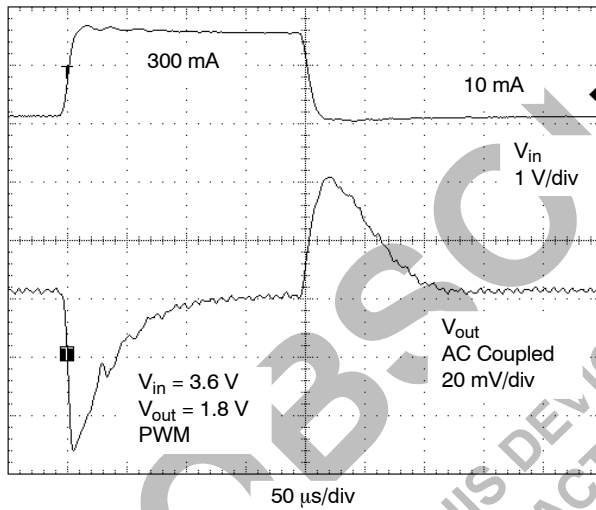

Figure 24. Load Transient Response

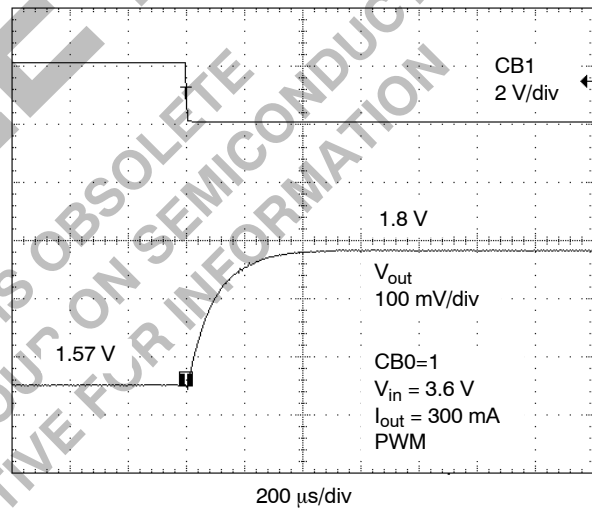

Figure 25. Output Voltage Transition from 1.57 V to 1.8 V

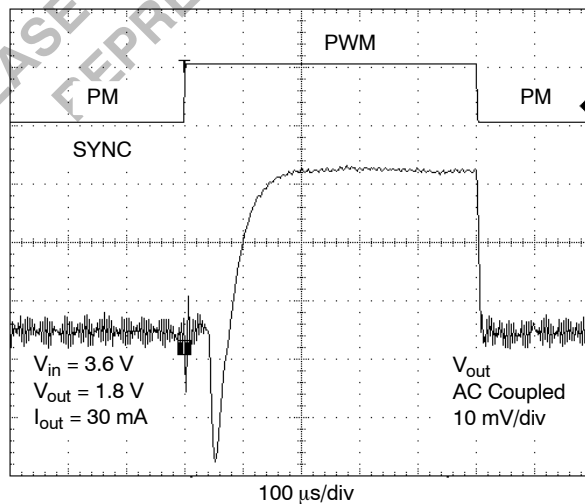

Figure 26. Transition between PWM and PM

DETAILED OPERATING DESCRIPTION

Overview

The NCP1510A is a monolithic micro-power high frequency PWM step-down DC-DC converter specifically optimized for applications requiring high efficiency and a small PCB footprint such as portable battery powered products. It integrates synchronous rectification to improve efficiency as well as eliminate the external Schottky diode. High switching frequency allows for a low profile inductor and capacitors to be used. Four digital selectable output voltages (1.05, 1.35, 1.57 and 1.8 V) can be generated from the input supply that can range from 2.7–5.2 V. All loop compensation is integrated as well further reducing the external component count as well.

The DC-DC converter has two operating modes (normal PWM, pulsed switching), which are intended to allow for optimum efficiency under either light (up to 30 mA) or heavy loads. The user determines the operating mode by controlling the SYNC input. In addition the SYNC input can be used to synchronize the PWM to an external system clock signal in the range of 500–1000 kHz.

PWM Operating Mode

The NCP1510A can be set to current mode PWM operation by connecting SYNC pin to V_{CC} . In this mode, the output voltage is regulated by modulating the on-time pulse width of the main switch Q1 at a fixed frequency of 1.0 MHz. The switching of the PMOS Q1 is controlled by a flip-flop driven by the internal oscillator and a comparator that compares the error signal from an error amplifier with the sum of the sensed current signal and compensation ramp. At the beginning of each cycle, the main switch Q1 is turned ON by the rising edge of the internal oscillator clock. The inductor current ramps up until the sum of the current sense signal and compensation ramp becomes higher than the error voltage amplifier. Once this has occurred, the PWM comparator resets the flip-flop, Q1 is turned OFF and the synchronous switch Q2 is turned ON. Q2 replaces the external Schottky diode to reduce the conduction loss and improve the efficiency. To avoid overall power loss, a certain amount of dead time is introduced to ensure Q1 is completely turned OFF before Q2 is being turned ON.

In continuous conduction mode (CCM), Q1 is turned ON after Q2 is completely turned OFF to start a new clock cycle. In discontinuous conduction mode (DCM), the zero crossing comparator (ZLC) will turn off Q2 when the inductor current drops to zero.

Overvoltage Protection

The overvoltage protection circuit is present in PWM mode to prevent the output voltage from going too high under light load or fast load transient conditions. The output overvoltage threshold is 5% above nominal set value. If the output voltage rises above 5% of the nominal

value, the OVP comparator is activated and switch Q1 is turned OFF. Switching will continue when the output voltage falls below the threshold of OVP comparator.

Pulsed Mode (PM)

Under light load conditions (< 30 mA), The NCP1510A can be configured to enter a low current pulsed mode operation to reduce power consumption. This is accomplished by applying a logic LOW to the SYNC pin. The output regulation is implemented by pulse frequency modulation. If the output voltage drops below the threshold of PM comparator (typically $V_{nom}-2\%$), a new cycle will be initiated by the PM comparator to turn on the switch Q1. Q1 remains ON until the peak inductor current reaches 200 mA (nom). Then ILIM comparator goes high to switch off Q1. After a short dead time delay, switch rectifier Q2 is turn ON. The zero crossing comparator will detect when the inductor current drops to zero and send the signal to turn off Q2. The output voltage continues to decrease through discharging the output capacitor. When the output voltage falls below the threshold of the PM comparator again, a new cycle starts immediately.

Cycle-by-Cycle Current Limit

From the block diagram (Figure 3), an ILIM comparator is used to realize cycle-by-cycle current limit protection. The comparator compares the LX pin voltage with the reference voltage from the SENFET, which is biased by a constant current. If the inductor current reaches the limit, the ILIM comparator detects the LX voltage falling below the reference voltage from the SENFET and releases the signal to turn off the switch Q1. The cycle-by-cycle current limit is set at 800 mA (nom) in PWM and 200 mA in PM.

Frequency Synchronization and Operating Mode Selection

The SYNC pin can also be used for frequency synchronization by connecting it with an external clock signal. It operates in PWM mode when synchronized to an external clock. The switching cycle initiates by the rising edge of the clock. The 500 kHz to 1000 kHz synchronization clock signal should be between 0.4 V and 1.2 V.

Gating on and off the clock, the SYNC pin can also be used to select between PM and PWM modes. It allows efficient dynamical power management by adjusting the converter operation to the specific system requirement. Set SYNC pin low to select PM mode at light load conditions (up to 30 mA) and set SYNC pin high or connect with external clock to select PWM mode at heavy load condition to achieve optimum efficiency. Table 1 shows the mode selection with three different SYNC pin states.

Table 1. Operating Mode Selection

SYNC Pin State	Operating Mode
LOW	Pulsed Mode (PM)
HIGH	PWM, 1 MHz Switch Frequency
CLOCK	PWM, Frequency Synchronization

Output Voltage Selection

The output voltage is digitally programmed to one of four voltage levels depending on the logic state of CB0 and CB1. Therefore if the NCP1510A's load, such as a digital cellular phone's baseband processor, supports dynamic power management, the device can lower or raise its core voltage under software control. When combined with the pulsed current mode function in low load situations, this active voltage management further stretches the useful operating life of the handset battery between charges.

The output voltage levels are listed in Table 2. The CB0 has a pull down resistor and the CB1 has a pullup resistor. The default output voltage is 1.35 V when CB0 and CB1 are floating.

Table 2. Truth Table for CB0 and CB1 with the corresponding output voltage

CB0	CB1	Vout(V)
0	0	1.05
0	1	1.35
1	1	1.57
1	0	1.8

Soft-Start

The NCP1510A uses soft-start to limit the inrush current when the device is initially powered up or enabled. Soft-start is implemented by gradually increasing the reference voltage until it reaches the full reference voltage. During startup, a pulsed current source charges the internal soft-start capacitor to provide gradually increasing reference voltage for the PWM loop. When the voltage across the capacitor ramps up to the nominal reference voltage, the pulsed current source will be switched off and the reference voltage will switch to the regular reference voltage.

Shutdown Mode

When the SHD pin has a voltage applied of less than 0.4 V, the NCP1510A will be disabled. In shutdown mode, the internal reference, oscillator and most of the control circuitries are turned off. Therefore, the typical current consumption will be 0.1 μ A (typical value).

Applying a voltage above 1.2 V to SHD pin will enable the device for normal operation. The device will go through soft-start to normal operation.

Thermal Shutdown

Internal Thermal Shutdown circuitry is provided to protect the integrated circuit in the event that the maximum junction temperature is exceeded. If the junction temperature exceeds 160°C, the device shuts down. In this mode switch Q1 and Q2 and the control circuits are all turned off. The device restarts in soft-start after the temperature drops below 135°C. This feature is provided to prevent catastrophic failures from accidental device overheating and it is not intended as a substitute for proper heatsinking.

APPLICATIONS INFORMATION

Component Selection

Input Capacitor Selection

In PWM operating mode, the input current is pulsating with large switching noise. Using an input bypass capacitor reduces the peak current transients drawn from the input supply source, thereby reducing switching noise significantly. The capacitance needed for the input bypass capacitor depends on the source impedance of the input supply. The RMS capacitor current is calculated as:

$$I_{RMS} \approx I_O \sqrt{D \cdot D'} \quad (\text{eq. 1})$$

where:

D = duty cycle, which equals V_{out}/V_{in} , and $D' = 1 - D$.

The maximum RMS current occurs at 50% duty cycle with maximum output current, which is $I_{O,max}/2$.

A low profile ceramic capacitor of 10 μF should be used for most of the cases. For effective bypass results, the input capacitor should be placed as close as possible to the V_{CC} pin.

Inductor Value Selection

Selecting the proper inductor value is based on the desired ripple current. The relationship between the inductance and the inductor ripple current is given by the equation below.

$$\Delta i_L = \frac{V_{out}}{L f_s} \left(1 - \frac{V_{out}}{V_{in}} \right) \quad (\text{eq. 2})$$

The DC current of the inductor should be at least equal to the maximum load current plus half the ripple current to prevent core saturation. For NCP1510A, the compensation is internally fixed and a fixed 6.8 μH inductor is needed for most of the applications. For better efficiency, choose a low DC resistance inductor.

Output Capacitor Selection

Selecting the proper output capacitor is based on the desired output ripple voltage. Ceramic capacitors with low ESR values will have the lowest output ripple voltage and are strongly recommended. The output ripple voltage is given by:

$$\Delta V_C = \Delta i_L \cdot \left(\text{ESR} + \frac{1}{4f_s C_{out}} \right) \quad (\text{eq. 3})$$

The RMS output capacitor current is given by:

$$I_{RMS}(C_{out}) = \frac{V_O \cdot (1 - D)}{2\sqrt{3} \cdot L \cdot f_s} \quad (\text{eq. 4})$$

Where f_s is the switching frequency and ESR is the effective series resistance of the output capacitor. A low ESR, 22 μF ceramic capacitor is recommended for NCP1510A in most of applications. For example, with TDK C2012X5R0J226 output capacitor, the output ripple is less than 10 mV at 300 mA.

Design Example

As a design example, assume that the NCP1510A is used in a single lithium-ion battery application. The input voltage, V_{in} , is 3.0 V to 4.2 V. Output condition is V_{out} at 1.8 V with a typical load current of 120 mA and a maximum of 300 mA. For NCP1510A, the inductor has a predetermined value, 6.8 μH . The inductor ESR will factor into the overall efficiency of the converter. The inductor needs to be selected by the required peak current.

Equation 5 is the basic equation for an inductor and describes the voltage across the inductor. The inductance value determines the slope of the current of the inductor.

$$\frac{V_L}{L} = \frac{di_L}{dt} \quad (\text{eq. 5})$$

Equation 5 is rearranged to solve for the change in current for the on-time of the converter in Continuous Conduction Mode.

$$i_{L, \text{pk-pk}} = \frac{(V_{in} - V_{out})}{L} \cdot DT_s$$

$$= \frac{(V_{in} - V_{out})}{L} \cdot \frac{V_{in}}{V_{out}} \cdot \frac{1}{f_s} \quad (\text{eq. 6})$$

$$i_{L, \text{max}} = I_{O, \text{max}} + \frac{\Delta i_{L, \text{pk-pk}}}{2}$$

Utilizing Equations 6, the peak-to-peak inductor current is calculated using the following worst-case conditions.

$$V_{in, \text{max}} = 4.2 \text{ V}, V_{out} = 1.8 \text{ V}, f_s = 1 \text{ MHz}-20\%$$

$$L = 6.8 \mu\text{H}-10\%, i_{L, \text{pk-pk}} = 211 \text{ mA}, i_{L, \text{max}} = 405 \text{ mA}$$

Therefore, the inductor must have a maximum current exceeding 405 mA.

Since the compensation is fixed internally in the IC, the input and output capacitors as well as the inductor have a predetermined value too: $C_{in} = 10 \mu\text{F}$ and $C_{out} = 22 \mu\text{F}$. Low ESR capacitors are needed for best performance. Therefore, ceramic capacitors are recommended.

NCP1510A

PCB Layout Recommendations

Good PCB layout plays an important role in switching mode power conversion. Careful PCB layout can help to minimize ground bounce, EMI noise and unwanted feedback that can affect the performance of the converter. Hints suggested below can be used as a guideline in most situations.

1. Use star-ground connection to connect the IC ground nodes and capacitor GND nodes together at one point. Keep them as close as possible, and then connect this to the ground plane through several vias. This will reduce noise in the ground plane by preventing the switching currents from flowing through the ground plane.

2. Place the power components (i.e., input capacitor, inductor and output capacitor) as close together as possible

for best performance. All connecting traces must be short, direct, and wide to reduce voltage errors caused by resistive losses through the traces.

3. Separate the feedback path of the output voltage from the power path. Keep this path close to the NCP1510A circuit. And also route it away from noisy components. This will prevent noise from coupling into the voltage feedback trace.

4. Place the DC-DC converter away from noise sensitive circuitry, such as RF circuits.

The following shows the NCP1510A demo board layout and bill of materials:

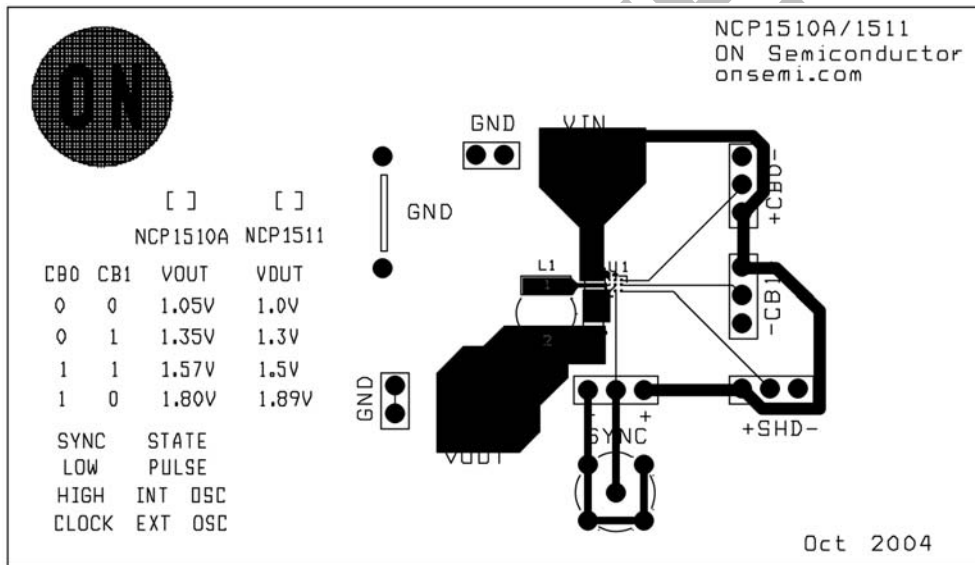

Figure 27. Top and Silkscreen Layer

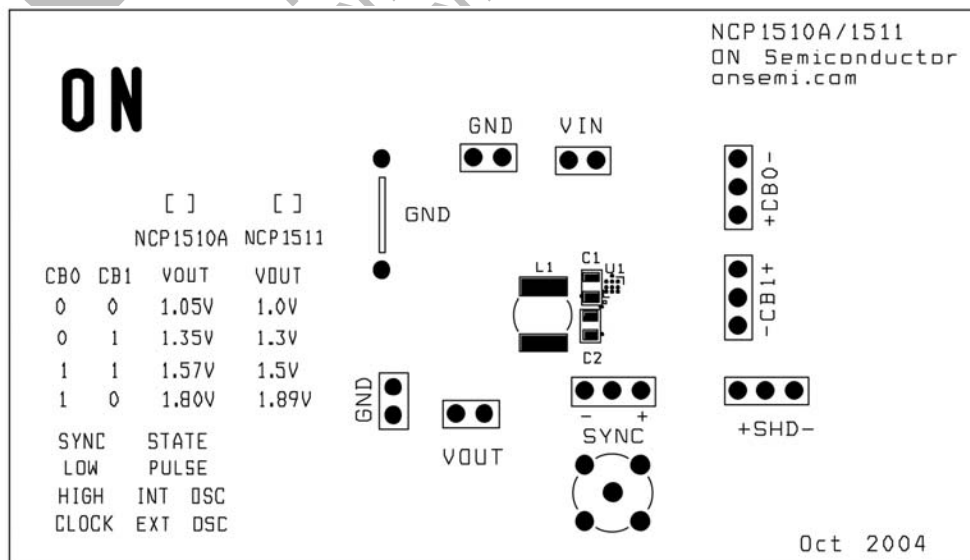

Figure 28. Soldermask Top and Silkscreen Layer

NCP1510A

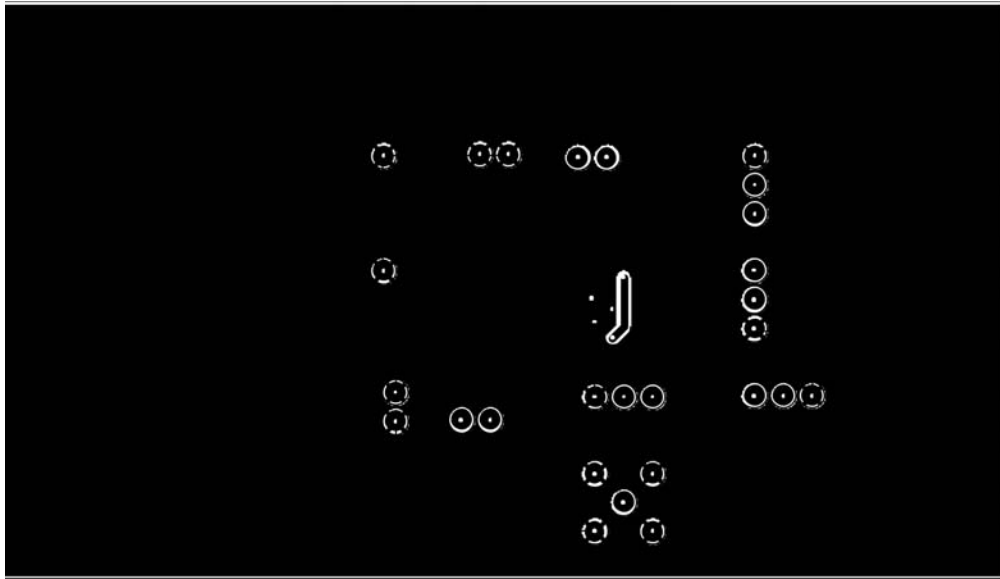

Figure 29. Bottom Layer

Table 3. Bill of Materials

Component	Value	Manufacturer	Part Number	Size (mm)	I _{out} (mA)	ESR (mΩ)
C _{in}	10 μF, X5R, 6.3 V	TDK Murata	C2012X5R0J106 GRM21BR60J106	2.0 x 1.25 x 1.25	–	–
C _{out}	22 μF, X5R, 6.3 V	TDK Murata	C2012X5R0J226 GRM21BR60J226	2.0 x 1.25 x 1.25	–	–
L	6.8 μH	TDK Coilcraft Coilcraft Sumida	VLCF4020-6R8 0805PS-682 LPO4812 CLS4D11	4.0 x 4.0 x 2.0 3.4 x 3.0 x 1.8 4.8 x 4.8 x 1.2 4.9 x 4.9 x 1.2	500** 210* 340* 500**	146 1260 225 220

*Output current calculated from $V_{CC} = 4.2 V_{max}$, $1.5 V_{out}$ and $Freq = 700 \text{ kHz}$ (1.0 MHz – 20 %).

**Calculated output current from $V_{CC} = 4.2 V_{max}$ and $Freq = 700 \text{ kHz}$ exceeds 640 mA ($I_{lim} - 20\%$). Therefore maximum output for these conditions shown as 500 mA.

NCP1510A

PACKAGE DIMENSIONS

9 PIN MICRO BUMP FC SUFFIX CASE 499AC-01 ISSUE B

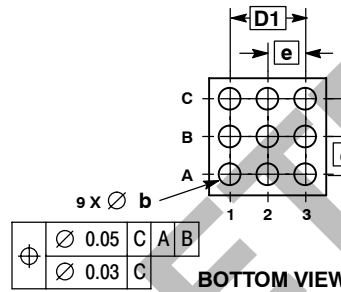
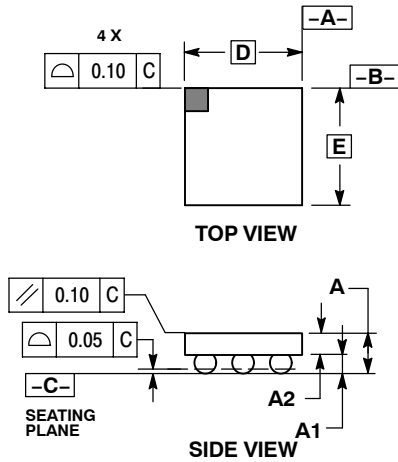

NOTES:

1. DIMENSIONING AND TOLERANCING PER ANSI Y14.5M, 1982.
2. CONTROLLING DIMENSION: MILLIMETERS.
3. COPLANARITY APPLIES TO SPHERICAL CROWNS OF SOLDER BALLS.

MILLIMETERS		
DIM	MIN	MAX
A	0.540	0.660
A1	0.210	0.270
A2	0.330	0.390
D	1.550 BSC	
E	1.550 BSC	
b	0.290	0.340
e	0.500 BSC	
D1	1.000 BSC	
E1	1.000 BSC	

SOLDERING FOOTPRINT*

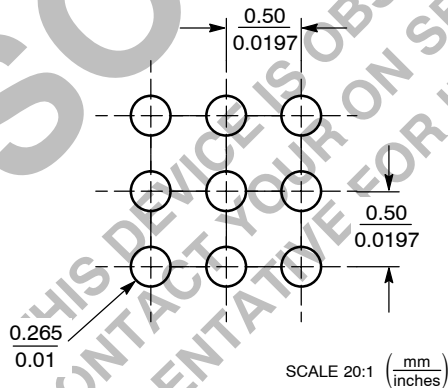

*For additional information on our Pb-Free strategy and soldering details, please download the ON Semiconductor Soldering and Mounting Techniques Reference Manual, SOLDERRM/D.

ON Semiconductor and are registered trademarks of Semiconductor Components Industries, LLC (SCILLC). SCILLC reserves the right to make changes without further notice to any products herein. SCILLC makes no warranty, representation or guarantee regarding the suitability of its products for any particular purpose, nor does SCILLC assume any liability arising out of the application or use of any product or circuit, and specifically disclaims any and all liability, including without limitation special, consequential or incidental damages. "Typical" parameters which may be provided in SCILLC data sheets and/or specifications can and do vary in different applications and actual performance may vary over time. All operating parameters, including "Typicals" must be validated for each customer application by customer's technical experts. SCILLC does not convey any license under its patent rights nor the rights of others. SCILLC products are not designed, intended, or authorized for use as components in systems intended for surgical implant into the body, or other applications intended to support or sustain life, or for any other application in which the failure of the SCILLC product could create a situation where personal injury or death may occur. Should Buyer purchase or use SCILLC products for any such unintended or unauthorized application, Buyer shall indemnify and hold SCILLC and its officers, employees, subsidiaries, affiliates, and distributors harmless against all claims, costs, damages, and expenses, and reasonable attorney fees arising out of, directly or indirectly, any claim of personal injury or death associated with such unintended or unauthorized use, even if such claim alleges that SCILLC was negligent regarding the design or manufacture of the part. SCILLC is an Equal Opportunity/Affirmative Action Employer. This literature is subject to all applicable copyright laws and is not for resale in any manner.

PUBLICATION ORDERING INFORMATION

LITERATURE FULFILLMENT:
Literature Distribution Center for ON Semiconductor
P.O. Box 5163, Denver, Colorado 80217 USA
Phone: 303-675-2175 or 800-344-3860 Toll Free USA/Canada
Fax: 303-675-2176 or 800-344-3867 Toll Free USA/Canada
Email: orderlit@onsemi.com

N. American Technical Support: 800-282-9855 Toll Free
USA/Canada
Europe, Middle East and Africa Technical Support:
Phone: 421 33 790 2910
Japan Customer Focus Center
Phone: 81-3-5773-3850

ON Semiconductor Website: www.onsemi.com
Order Literature: <http://www.onsemi.com/orderlit>

For additional information, please contact your local Sales Representative